

## Backwater pump station, Pumpfix F DN 125, Floor slab, tileable

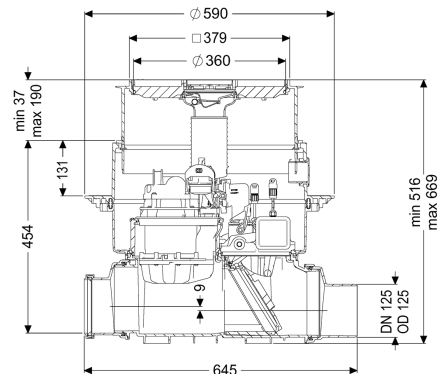

### Article information

Item no.: 24125X  
 GTIN: 4026092046555  
 Price group: 30

### Advantages

- Backwater pumping station: uses the natural fall to the sewer - pump is only used for backwater
- Flexible installation, different covers with drain function available for installation in the floor slab
- Quiet and energy-saving

### Description

The premium backwater pumping station for faecal and non-faecal wastewater is equipped with a pump and a motor-driven closure system. The pipe cross-section is normally open. In case of backwater, the motor-driven closure system is closed automatically. During the backwater phase, the water drains via the pump with integrated macerator. The station is controlled by a user-friendly control unit, which is optionally integrated in the building management system via a potential-free contact, or alarm and collective fault messages can be output via a GSM interface.

#### Variant

Emergency closure:	yes
Pump control:	Control unit
Protection class, probe:	IP 68 (3m/48h)
Motor-driven backwater flaps:	1

#### General characteristics

Colour:	black
Nominal size (DN):	125
Outer diameter (OD):	125 mm
Type of wastewater:	with sewage
Installation situation:	floor slab installation

Delivery state:	Pre-mounted for final assembly on site (pumps and sensor system must be fitted on site and control unit must be connected)
Approval:	Z-53.2-388
Motor type:	KSM 140
Type de protection moteur:	IP 68 (3m/48h)
Odour trap:	Multistop
<b>Dimensions</b>	
Net weight:	30,2 kg
Gross weight:	33 kg
Groundwater resistant from lower edge of base section:	3000 mm
Cutout dimension, width:	750 mm
Cutout dimension, length:	750 mm
Vertical drop between inlet and outlet:	9 mm
Installation depth:	516 - 669 mm
Type of height adjustability:	vertically adjustable upper section
Length:	645 mm
Width:	590 mm
Packaging dimension:	length
Packaging dimension:	width
Packaging dimension:	height
Tank/drain body	
Socket version:	including spigot and socket
<b>Coverage features</b>	
Type of cover:	tileable cover plate
Cover material:	Polymer
Width of cover:	366 mm
Length of cover:	366 mm
Drainage function:	yes
Locking:	Lock & Lift
Load class:	K 3 (EN 1253-1)
Max. flooring height:	16 mm
<b>Pumping device</b>	
Pump:	SPZ 1000
Number of pumps:	1
Weight, pump:	10 kg
Connection type:	coded plug
Rated current:	5,2 A
Protection class:	I
Insulation class:	F
Cos phi - power factor:	0,97
Protection class (pump):	IP 68 (3m/48h)
Temperature monitoring:	integrated
Max. temperature (permanent) of conveyed material:	40 °C

Max. pumping capacity:	11,5 m <sup>3</sup> /h
Max. pumping height:	10 m
Speed:	2800 U/min
Power P1:	1,2 kW
Power P2:	0,69 kW
Operating mode:	S3 - 50 %
Type of fuse required (electrical protection):	C 16 A
Type of pump connection cable:	H07RN-F 3G 1.5 mm <sup>2</sup>
Impeller type:	Macerator
Motor connection cable type:	ÖPVC-JB/OB 300/500 V/3 x 0,75 mm <sup>2</sup> mm <sup>2</sup>
Sensor connection cable type:	ÖPVC-JB/OB 300/500 V/3 x 0,75 mm <sup>2</sup> mm <sup>2</sup>
Length of mains cable for pump:	5 m
Control	
Control unit:	Comfort
Alarm sensor:	optical probe
Level measurement instrument:	optical probe
Type of level measurement:	optical
Protection class control unit:	IP 54
Operating voltage:	230 V
Connection type:	coded plug
Length of mains cable for control unit:	1,4 m
Potential-free contact:	optional
GSM interface:	yes
USB interface:	yes
Log book function:	yes
Multi-line display:	yes
Battery buffering:	yes
Self-diagnosis system (SDS):	yes
Type of fuse required (electrical protection):	C 16 A