

Ecoguss project drain glu. flange DN 80, vert., Variofix, Design cover

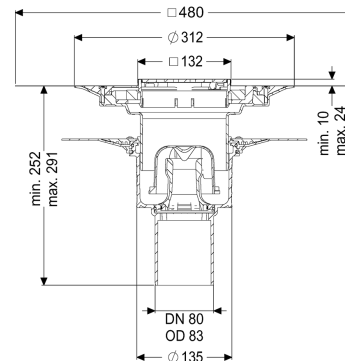
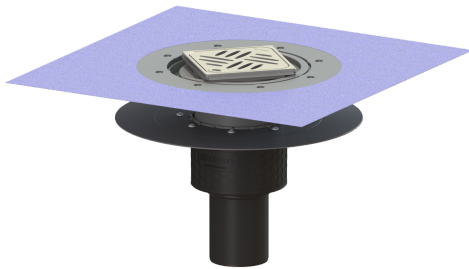

Article information

Item no.: 48683.53
 GTIN: 4026092054284
 Price group: 40

Advantages

- High-tech Ecoguss composite material
- Ecoguss, highest fire protection standards
- Scientifically confirmed sound protection effect

Description

The Ecoguss floor/roof drain is used for point drainage and is equipped with a glued flange, a removable odour trap, a lip seal and a temporary protective cover. The recyclable composite material Ecoguss fulfils the highest sound protection requirements, is resistant to aggressive media, temperature resistant and has a permanently corrosion-free surface. It can be exposed to flames of 100 up to 400 degrees Celsius for short periods. The glued flange with a flange width of 50 mm is suitable for connecting waterproofing layers in accordance with DIN 18534, for all waterproofing classes. The loose flange is used for clamping polymer and elastomer sealing sheets as well as for cold bitumen seals and is therefore only suitable for use with moisture barriers. The outlet socket is suitable for connection to SML cast iron pipes. Separate equipotential bonding is not necessary.

Variant

System:	125
Waterproofing layer on the upper section:	Enclosed sealing collar to be glued (bd) according to DIN 18534
Waterproofing layer on the drain body:	Adhesive flange (suitable for moisture barriers)
Water exposure class in accordance to DIN 18534-1 (up to and including):	W3-I
Sealing water height:	50 mm
General characteristics	
Standard:	EN 1253-1
Nominal size (DN):	80
Outer diameter (OD):	83 mm

Approval:	Z-19.53-2414,Z-19.17-1719
Odour trap:	included
Dimensions	
Net weight:	2,73 kg
Gross weight:	3,64 kg
Diameter:	348 mm
Type of height adjustability:	vertically adjustable upper section
Length:	348 mm
Width:	348 mm
Packaging dimension:	length
Packaging dimension:	width
Packaging dimension:	height
Tank/drain body	
Number of outlets:	1
Material of drain body:	Ecoguss
Socket version:	vertical
Coverage features	
Type of cover:	Design cover
Cover material:	Stainless steel 14301
Colour of cover:	silver
Width of cover:	120 mm
Length of cover:	120 mm
Min. flooring height:	10 mm
Surface:	ground
Frame material:	Stainless steel 14301
Locking:	Lock & Lift
Load class:	L 15 (EN 1253-1)
Grating design:	Kessel
Slip resistance class:	R9 according to DIN 51130; C according to DIN 51097
Rim width:	132 mm
Rim length:	132 mm
Max. flooring height:	24 mm
Upper section:	adjustable in three dimensions
Shape of upper section:	square
Upper section material:	ABS