

Ecoguss project drain, press. fl. DN 50, vert., Variofix, Design cover

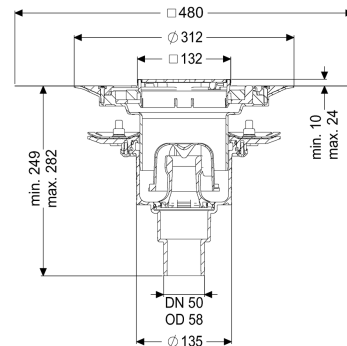
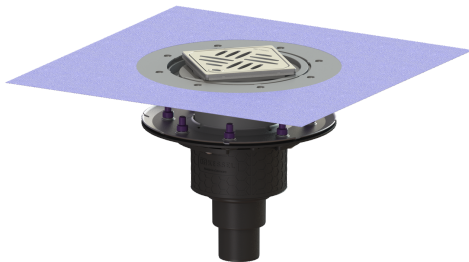

Article information

Item no.: 48858.53
 GTIN: 4026092034545
 Price group: 40

Advantages

- Scientifically confirmed sound protection effect
- Highest fire protection standards

Description

The Ecoguss project drain is used for point drainage and is equipped with a pressure sealing flange as well as a removable odour trap, a lip seal and a temporary protective cover. The recyclable composite material Ecoguss meets the highest noise protection requirements, is temperature-resistant, resistant to aggressive media, and has a permanently corrosion-free surface. It is also briefly flammable from 100 to 400 degrees Celsius. The pressure sealing flange with bolts and screws made of stainless steel is used for the clamping or welding of bitumen and polymer bitumen sheets as well as for polymer and elastomer sealing sheets. Only the sealing sheets tested by the manufacturer may be used for watertight seals. The outlet socket is suitable for connection to SML cast iron pipes. Separate equipotential bonding is not necessary.

Variant

System:	125
Waterproofing layer on the upper section:	Enclosed sealing collar to be glued (bd) according to DIN 18534
Waterproofing layer on the drain body:	Press sealing flange (suitable for creating watertight seals)
Sealing water height:	50 mm

General characteristics

Standard:	EN 1253-1
Nominal size (DN):	50
Outer diameter (OD):	58 mm
Approval:	Z-19.53-2414,Z-19.17-1719

Odour trap:	included
Dimensions	
Net weight:	3,56 kg
Gross weight:	4,55 kg
Diameter:	273 mm
Type of height adjustability:	vertically adjustable upper section
Length:	273 mm
Width:	273 mm
Packaging dimension:	length
Packaging dimension:	width
Packaging dimension:	height
Tank/drain body	
Number of outlets:	1
Material of drain body:	Ecoguss
Socket version:	vertical
Coverage features	
Type of cover:	Design cover
Cover material:	Stainless steel 14301
Colour of cover:	silver
Width of cover:	120 mm
Length of cover:	120 mm
Min. flooring height:	10 mm
Surface:	ground
Frame material:	Stainless steel 14301
Locking:	Lock & Lift
Load class:	L 15 (EN 1253-1)
Grating design:	Kessel
Slip resistance class:	R9 according to DIN 51130; C according to DIN 51097
Rim width:	132 mm
Rim length:	132 mm
Max. flooring height:	24 mm
Upper section:	adjustable in three dimensions
Shape of upper section:	square
Upper section material:	ABS