

## Backwater valve Staufix SWA DN 125, Floor slab, black

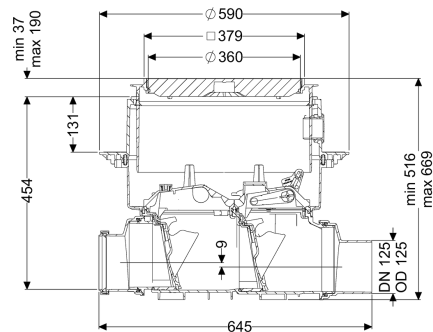

### Article information

Item no.: 73125.10S  
 GTIN: 4026092003947  
 Price group: 30

### Advantages

- Simple conversion to Staufix FKA or Pumpfix F
- Fast, simple and toolless maintenance
- Available as a complete set or module set

### Description

The premium backwater valve for wastewater without sewage is equipped with two mechanical flaps which close automatically in the event of backwater. One flap serves at the same time as an emergency closure to be closed by hand. Thanks to the modular KESSEL system, existing systems can easily be converted to a Staufix FKA premium backwater valve or a Pumpfix F backwater pumping station.

#### Variant

Emergency closure: yes  
 Mechanical backwater flaps: 2

#### General characteristics

Colour: black  
 Standard: EN 13564  
 Nominal size (DN): 125  
 Outer diameter (OD): 125 mm  
 Type of wastewater: without sewage  
 Installation situation: floor slab installation  
 Delivery state: Installation-ready (connection parts must be connected on site)  
 Backwater protection: Type 2

#### Dimensions

Net weight: 13,5 kg  
 Gross weight: 18,12 kg

Groundwater resistant from lower edge of base section:	3000 mm
Cutout dimension, width:	750 mm
Cutout dimension, length:	750 mm
Vertical drop between inlet and outlet:	9 mm
Installation depth:	516 - 669 mm
Type of height adjustability:	vertically adjustable upper section
Length:	645 mm
Width:	590 mm
Packaging dimension:	length
Packaging dimension:	width
Packaging dimension:	height
Tank/drain body	
Socket version:	including spigot and socket
Coverage features	
Type of cover:	Cover plate
Cover material:	Polymer
Colour of cover:	black
Width of cover:	366 mm
Length of cover:	366 mm
Locking:	Lock & Lift
Load class:	L 15 (EN 1253-1)
Tightness:	surface water resistant