

Staufix FKA auto. backwater valve DN 125, Floor slab, black

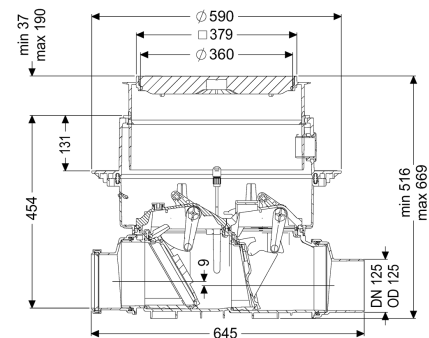

Article information

Item no.: 84125S
 GTIN: 4026092046388
 Price group: 30

Advantages

- Safe, motor-driven closure system with optical probe
- Fast, simple and toolless maintenance
- Available as a complete set or module set

Description

The Premium automatic backwater valve for faecal and faecal-free wastewater is equipped with a motor-driven closure system which is closed automatically in the event of backwater. A second closure system serves as an emergency closure to be closed by hand. The station is controlled by a user-friendly control unit, which is optionally integrated in the building management system via a potential-free contact, or alarm and collective fault messages can be output via a GSM interface. Thanks to the modular KESSEL system, existing systems can easily be converted to a Pumpfix F backwater pumping station.

Variant

Emergency closure:	yes
Protection class, probe:	IP 68 (3m/48h)
Motor-driven backwater flaps:	1
Mechanical backwater flaps:	1

General characteristics

Colour:	black
Standard:	EN 13564
Nominal size (DN):	125
Outer diameter (OD):	125 mm
Type of wastewater:	with sewage
Installation situation:	floor slab installation

Delivery state:	Pre-mounted for final assembly on site (sensor system must be fitted on site and control unit must be connected)
Backwater protection:	Type 3
Motor type:	KSM 140
Type de protection moteur:	IP 68 (3m/48h)
Cable length:	5 m
Dimensions	
Net weight:	16,5 kg
Gross weight:	21,37 kg
Groundwater resistant from lower edge of base section:	3000 mm
Cutout dimension, width:	750 mm
Cutout dimension, length:	750 mm
Vertical drop between inlet and outlet:	9 mm
Installation depth:	516 - 669 mm
Type of height adjustability:	vertically adjustable upper section
Length:	645 mm
Width:	590 mm
Packaging dimension:	length
Packaging dimension:	width
Packaging dimension:	height
Tank/drain body	
Socket version:	including spigot and socket
Coverage features	
Type of cover:	Cover plate
Cover material:	Polymer
Colour of cover:	black
Width of cover:	366 mm
Length of cover:	366 mm
Locking:	Lock & Lift
Load class:	L 15 (EN 1253-1)
Tightness:	surface water resistant
Control	
Control unit:	Comfort
Alarm sensor:	optical probe
Level measurement instrument:	optical probe
Type of level measurement:	optical
Protection class control unit:	IP 54
Mains frequency:	50 Hz
Operating voltage:	230 V
Length of mains cable for control unit:	1,4 m
Potential-free contact:	optional
GSM interface:	yes
USB interface:	yes
Log book function:	yes

Multi-line display:	yes
Battery buffering:	yes
Self-diagnosis system (SDS):	yes
Connection to the BCS, BAC:	yes