

Pump system Aquapump Retrofit Duo, GTF 1600, Level sensor

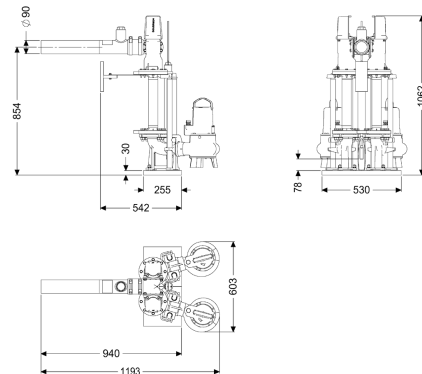

Article information

Item no.: 8744022
 GTIN: 4026092103524
 Price group: 60

Description

Twin pump system, for installation in an on-site chamber module. Required minimum diameter of the on-site chamber: 1000 mm

Variant

Type of system:	duo pump
Shut-off valve:	yes
Installation:	Wet installation
Pump control:	Control unit
Backflow preventer:	integrated
Pressure pipe connection:	vertical (special version, on request), horizontal (standard version)

General characteristics

Standard:	EN 12050-2 as well as EN 12050-1 (without ATEX requirements)
Type of wastewater:	for wastewater with or without sewage (in installation situations without ATEX requirements)
Installation situation:	installation in on-site collecting tank
System type:	Duo
ATEX:	no

Dimensions

Net weight:	119,6 kg
Gross weight:	119,6 kg

Packaging dimension:	length
Packaging dimension:	width
Packaging dimension:	height
Tank/drain body	
Pressure pipe connection (DN):	90
Pressure pipe connection (OD):	80 mm
Pumping device	
Pump:	GTF 1600
Number of pumps:	2
Connection type:	coded plug
Operating voltage:	400
Mains frequency:	50 Hz
Rated current:	2,9 A
Length of mains cable for pump:	10 m
Protection class:	I
Protection class (pump):	IP 68 (3m)
Temperature monitoring:	integrated
Max. temperature (permanent) of conveyed material:	40 °C
Max. pumping capacity:	49 m ³ /h
Max. pumping height:	9,3 m
Speed:	2900 U/min
Power P1:	1,6 kW
Power P2:	1,2 kW
Operating mode:	S1
Type of pump connection cable:	H07RN-F 3G 1.5 mm ²
Impeller type:	Multi-vane impeller
Type of fuse required (electrical protection):	3 x C 16 A
Control	
Control unit:	Comfort
Alarm sensor:	Level sensor
Level measurement instrument:	Level sensor
Type of level measurement:	hydrostatic
Protection class control unit:	IP 54
Mains frequency:	50 Hz
Operating voltage:	400 V
Connection type:	coded plug
Length of mains cable for control unit:	1,4 m
Potential-free contact:	optional
GSM interface:	yes
USB interface:	yes
Log book function:	yes
Multi-line display:	yes
Battery buffering:	yes
Self-diagnosis system (SDS):	yes
Type of fuse required (electrical protection):	3 x C 16 A
Rated current:	2,9 A