

Grease separator EasyClean free NS 20, Auto Mix, left

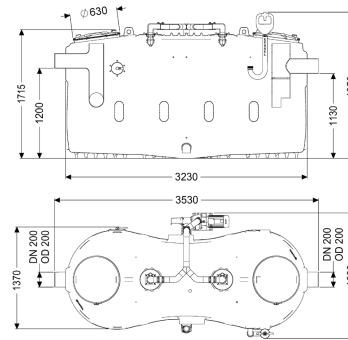

Article information

Item no.: 93020-01-DSP-L

GTIN: 4026092105139

Price group: 60

Advantages

- Direction of flow can be changed thanks to self-sealing interchangeable hubs (NS 2- NS 10)
- Low-maintenance operation
- Customisation possible through control unit

Description

The separator for greasy wastewater is suitable for free-standing set-up in frost-protected rooms and comes without metallic components in the tank. The collecting tank made of permanently resistant polymer (PE) is equipped with an integrated sludge trap and has a tapered base for fast and clean disposal. Two odour-tight covers with quick-release closures make easy access possible for cleaning and maintenance work. The innovative Shredder-Mix-System with integrated macerating system is responsible for homogenising and circulating the tank contents. Cleaning is carried out by an exterior pump which can be disconnected from the tank by a shut-off valve. A direct disposal pipe socket is available for odour-neutral manual disposal. The fully automatic program run is controlled by a user-friendly control unit with multi-line display that can be integrated into the building management system through a potential-free contact. Cleaning and disposal can be started remotely using the remote control, which is available as an option. Thanks to the customisable cleaning program with fast-selection function, cleaning can be adapted to the local circumstances as required. After disposal, a maximum of 3 litres residual sludge volume is left in the tank. Observance of the Drinking Water Hygiene Directive can be guaranteed through the fully automatic rinsing of the drinking water pipes. 20 year polyethylene warranty.

Variant

Shut-off valve:	yes
Direction of flow:	left
Disposal variant:	Auto Mix
Shredder-Mix-System:	yes

Sludge bucket:	yes
Nominal size (NS):	20,00
SonicControl:	no
Disposal system:	Disposal connection
Refill inlet in accordance with DIN 1988:	yes
Type of disposal:	automatic cleaning system
Water supply:	2 solenoid valves 1"
Load-bearing capacity (DIN 19901):	F3
General characteristics	
Material:	PE
Installation situation:	free-standing installation
Delivery state:	Installation-ready (electrical components, connection parts must be connected on site)
Scope of delivery:	Storz-B coupling R 2 1/2" for disposal vehicle connection
Dimensions	
Net weight:	410 kg
Gross weight:	485 kg
Set-up area, length:	3530 mm
Set-up area, width:	1680 mm
Set-up area, height:	1950 mm
Packaging dimension:	length
Packaging dimension:	width
Packaging dimension:	height
Tank/drain body	
Nominal pressure (PN):	10
Pressure pipe connection (DN):	65
Pressure pipe connection (OD):	75 mm
Distance pipe bottom outlet to tank bottom:	1130 mm
Distance pipe bottom inlet to tank bottom:	1200 mm
Outlet nominal size (OD):	200 mm
Outlet nominal size (DN):	200 mm
Inlet nominal size (OD):	200 mm
Inlet nominal size (DN):	200 mm
Connection inlet/outlet sockets:	PE-HD pipes in accordance with DIN 19537, HT pipes in accordance with DIN 19560, PP or AS
Servicing opening:	420 mm
Coverage features	
Type of cover:	Cover
Cover material:	Polymer
Colour of cover:	violet
Locking:	Quick-release closure
Tightness:	odour-tight
Wastewater contents	
Total volume:	3730 l

Contents of sludge trap:	2000 l
Storage quantity of grease:	800 l
Pumping device	
Pump:	SPF 300 KE 2.0
Number of pumps:	1
Connection type:	Direct connection
Rated current:	6,2 A
Protection class:	I
Insulation class:	F
Cos phi - power factor:	0,87
Protection class (pump):	IP 55
Temperature monitoring:	integrated
Max. temperature (permanent) of conveyed material:	40 °C
Max. pumping capacity:	60 m ³ /h
Max. pumping height:	17 m
Speed:	2850 U/min
Power P1:	3,6 kW
Power P2:	3 kW
Operating mode:	S2 - 30 min.
Type of fuse required (electrical protection):	Fuse protection through control unit 400 V
Type of pump connection cable:	H07RN-F 7G 1.5 mm ²
Impeller type:	Radial impeller with macerating system
Length of mains cable for pump:	5 m
Control	
Control unit:	yes
Motor protection switch:	yes
Type of fuse required (RCD):	30 mA
Protection class control unit:	IP 54
Mains frequency:	50 Hz
Operating voltage:	400 V
Connection type:	Direct connection
Potential-free contact:	yes
GSM interface:	no
USB interface:	no
Log book function:	yes
Multi-line display:	yes
Battery buffering:	no
Self-diagnosis system (SDS):	yes
Type of fuse required (electrical protection):	Fuse protection through control unit 400 V