

## Grease separator EasyClean free Basic, NS 7, Standard, universal

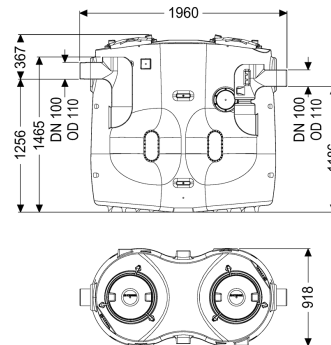

### Article information

Item no.: 94007.10  
 GTIN: 4026092084977  
 Price group: 60

### Advantages

- Low-maintenance operation

### Description

The separator for greasy wastewater is suitable for free-standing set-up in frost-protected rooms and comes without metallic components in the tank. The collecting tank made of permanently resistant polymer (PE) is equipped with an integrated sludge trap. Two odour-tight covers with quick-release closures allow for easy access for cleaning and maintenance work. Manual disposal is carried out with the tank open. 20 year polyethylene warranty.

#### Variant

Direction of flow:	universal
Disposal variant:	Standard
Sludge bucket:	no
Nominal size (NS):	7
Refill inlet in accordance with DIN 1988:	no
Type of disposal:	manual with suction hose
Sampling device:	no
Load-bearing capacity (DIN 19901):	F3

#### General characteristics

Material:	PE
Installation situation:	free-standing installation
Delivery state:	Installation-ready (connection parts must be connected on site)

#### Dimensions

Net weight:	140 kg
-------------	--------

Gross weight:	170 kg
Set-up area, length:	1960 mm
Set-up area, width:	920 mm
Set-up area, height:	1670 mm
Required access area, length:	1960 mm
Required access area, width:	920 mm
Required access area, height:	1670 mm
Packaging dimension:	length
Packaging dimension:	width
Packaging dimension:	height

#### Tank/drain body

Nominal pressure (PN):	10
Pressure pipe connection (DN):	65
Pressure pipe connection (OD):	75 mm
Distance pipe bottom outlet to tank bottom:	1185 mm
Distance pipe bottom inlet to tank bottom:	1255 mm
Outlet nominal size (OD):	160 mm
Outlet nominal size (DN):	150 mm
Inlet nominal size (OD):	160 mm
Inlet nominal size (DN):	150 mm
Connection inlet/outlet sockets:	PE-HD pipes in accordance with DIN 19537, HT pipes in accordance with DIN 19560, PP or AS

#### Coverage features

Type of cover:	Cover
Cover material:	Polymer
Colour of cover:	violet
Locking:	Quick-release closure
Tightness:	odour-tight

#### Wastewater contents

Max. grease layer thickness:	230 mm
Total volume:	1370 l
Contents of sludge trap:	700 l
Storage quantity of grease:	280 l