

Grease separator EasyClean ground NS 12,5, Direct, 995-1695 mm, D, left

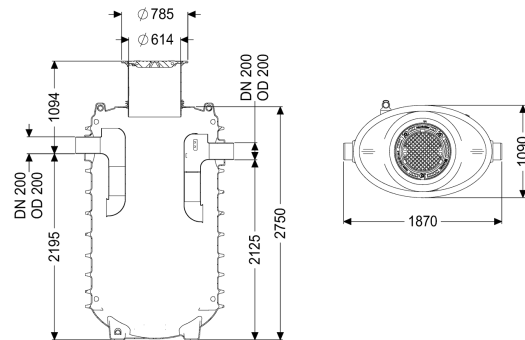

Article information

Item no.: 95125-120D-DL
 GTIN: 4026092101094
 Price group: 60

Advantages

- Low odour and clean disposal
- Defined disposal point
- Complete emptying of the separator

Description

The separator for greasy wastewater is suitable for installation in the ground and comes without metallic structural components in the tank. The collecting tank made of permanently resistant polymer (PE) is equipped with an integrated sludge trap, and has a rounded base for fast and clean disposal. Access for cleaning and maintenance work is possible via a service access cover. A direct disposal pipe socket is available for manual disposal. A load distribution slab must be installed on site for load class D. The reinforcement drawings are part of the EBA and are available from KESSEL. The tank is groundwater resistant up to ground level (GL). 20 year polyethylene warranty.

Variant

Note on installation depth:	Installation in the ground, frost-free depth 1200 mm
Direction of flow:	left
Disposal variant:	Direct
Nominal size (NS):	12,5
Disposal system:	Disposal pipe
Type of disposal:	manual
Load-bearing capacity (DIN 19901):	E4

General characteristics

Material:	PE
Standard:	EN 1825
Installation situation:	underground installation

Delivery state:	Installation-ready (connection parts must be connected on site)
Dimensions	
Net weight:	355 kg
Gross weight:	355 kg
Diameter:	648 mm
Installation depth:	855 - 1145 mm
Length:	1870 mm
Width:	1090 mm
Height:	2795 mm
Packaging dimension:	length
Packaging dimension:	width
Packaging dimension:	height
Tank/drain body	
Distance pipe bottom outlet to tank bottom:	2125 mm
Distance pipe bottom inlet to tank bottom:	2195 mm
Outlet nominal size (DN):	200 mm
Inlet nominal size (OD):	200 mm
Inlet nominal size (DN):	200 mm
Connection inlet/outlet sockets:	PE-HD pipes in accordance with DIN 19537, PVC-KG pipes in accordance with DIN 19534, PP or AS
Clear width of entry (LW):	600 mm
Coverage features	
Type of cover:	Cover plate
Cover material:	Grey iron
Colour of cover:	black
Locking:	Lock & Lift
Load class:	D 400 (EN 124)
Tightness:	odour-tight and surface water resistant
Wastewater contents	
Separator contents:	880 l
Max. grease layer thickness:	475 mm
Total volume:	2130 l
Contents of sludge trap:	1250 l
Storage quantity of grease:	500 l